

CATSKILL

C R A F T S M E N , I N C .

Assembly Instructions Model 1529 Cuisine Cart Deluxe



GENERAL:

1. You have purchased model 1529. Overall dimensions of an assembled unit is 21" x 15 1/4" x 34"
2. Should you need assistance or need to replace a damaged or missing part, DO NOT RETURN THE UNIT TO THE STORE where you purchased it, simply give us a call at 607-652-7321 from 7:30 - 4:00 PM Eastern time and we'll send you the prepaid part via UPS usually that same day! Please have model number and part description ready when you call.
3. Read the assembly instructions and the enclosed brochure before beginning assembly. Assembly is very easy if you read and follow the instructions step by step.
4. Tools required: Phillips screwdrivers, medium and small; medium flat blade screwdriver and hammer.

CABINET PARTS

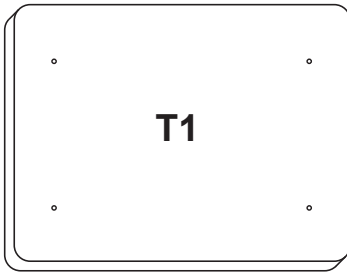

Cabinet Top(1)

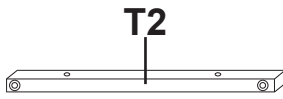

Table Top Stick (2)



Drawer Front (1)



Drawer Back (1)



Drawer Side Right (1)



Drawer Side Left (1)

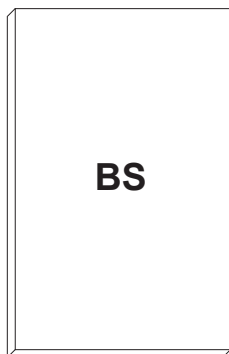

Bottom Shelf (1)

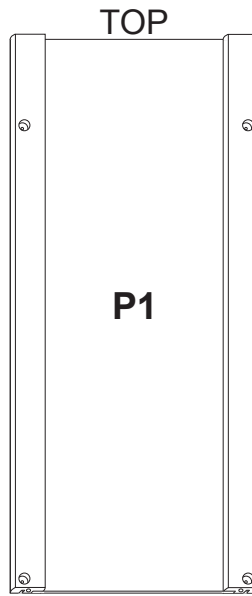

Side Panel (2)

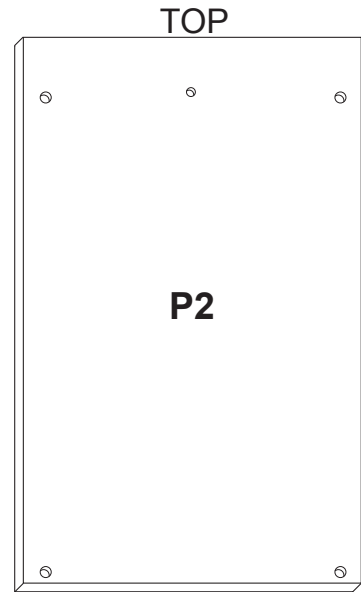

Back Panel (1)



Drawer Dowel (1)



Door Spacer (1)

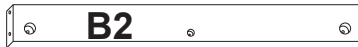

Bottom Brace (1)

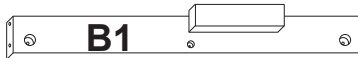

Middle Brace (1)

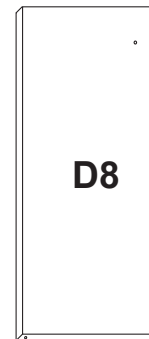

Left Door (1)

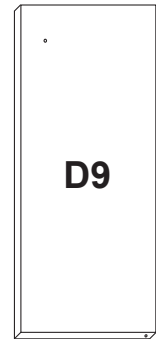

Right Door (1)

Middle Shelf has edge banding

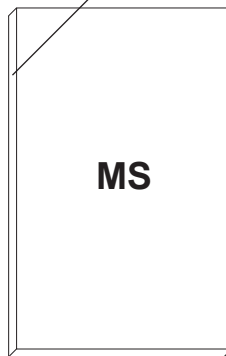

Middle Shelf (1)

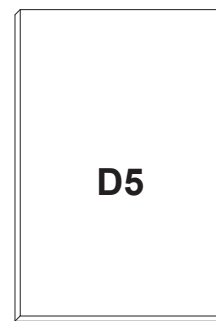

Drawer Bottom (1)

CABINET HARDWARE

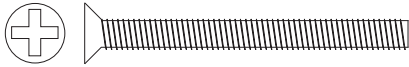

1 3/4" Phillips Flat Head Machine Screw (8)



1 1/4" Phillips Flat Head #8 Screw (12)

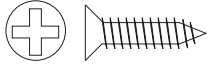

5/8" Phillips Flat Head #8 Screw (3)

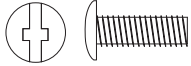

1/2" Truss Head Machine Screw (2)



1 1/4" Truss Head Machine Screw (2)



1 1/2" Long 3/16" DIA. Steel Pin (4)

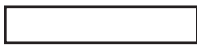

1" Long 3/16" DIA. Steel Pin (8)



3/4" Long 3/16" DIA. Steel Pin (4)

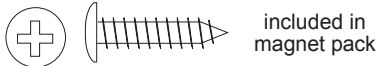

5/8" Pan Head Screw (2)

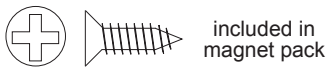

1/2" Phillips Flat Head #4 Screw (1)



Magnet (1)

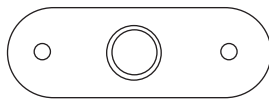

Magnet Plate (1)

included in magnet pack

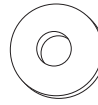

3/16" Flat Washer (2)

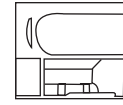

Cam (2)



10-24 Hex Nut (8)



5/8" Wooden Disk (8)

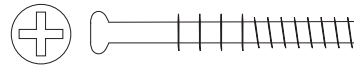

Cam Posts (2)

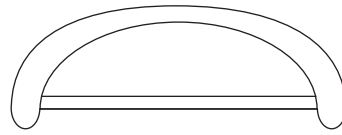

Cup Handle (1)

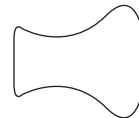

Door Knob (2)

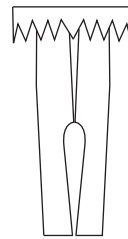

Caster Socket (4)

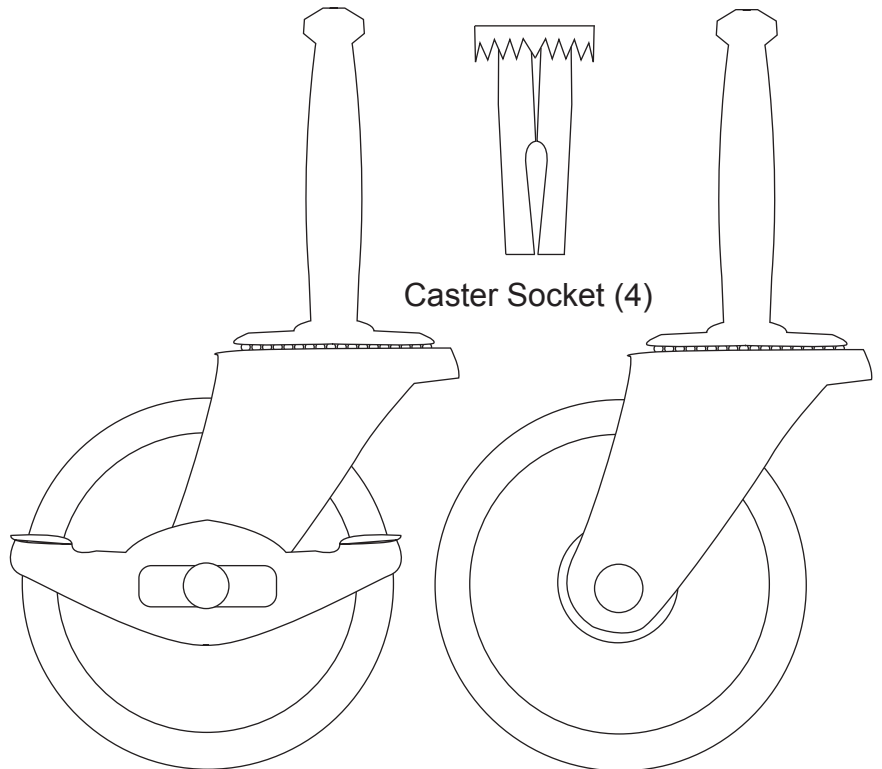

Locking Wheel Caster (2) Non Locking Wheel Caster (2)

STEP 1

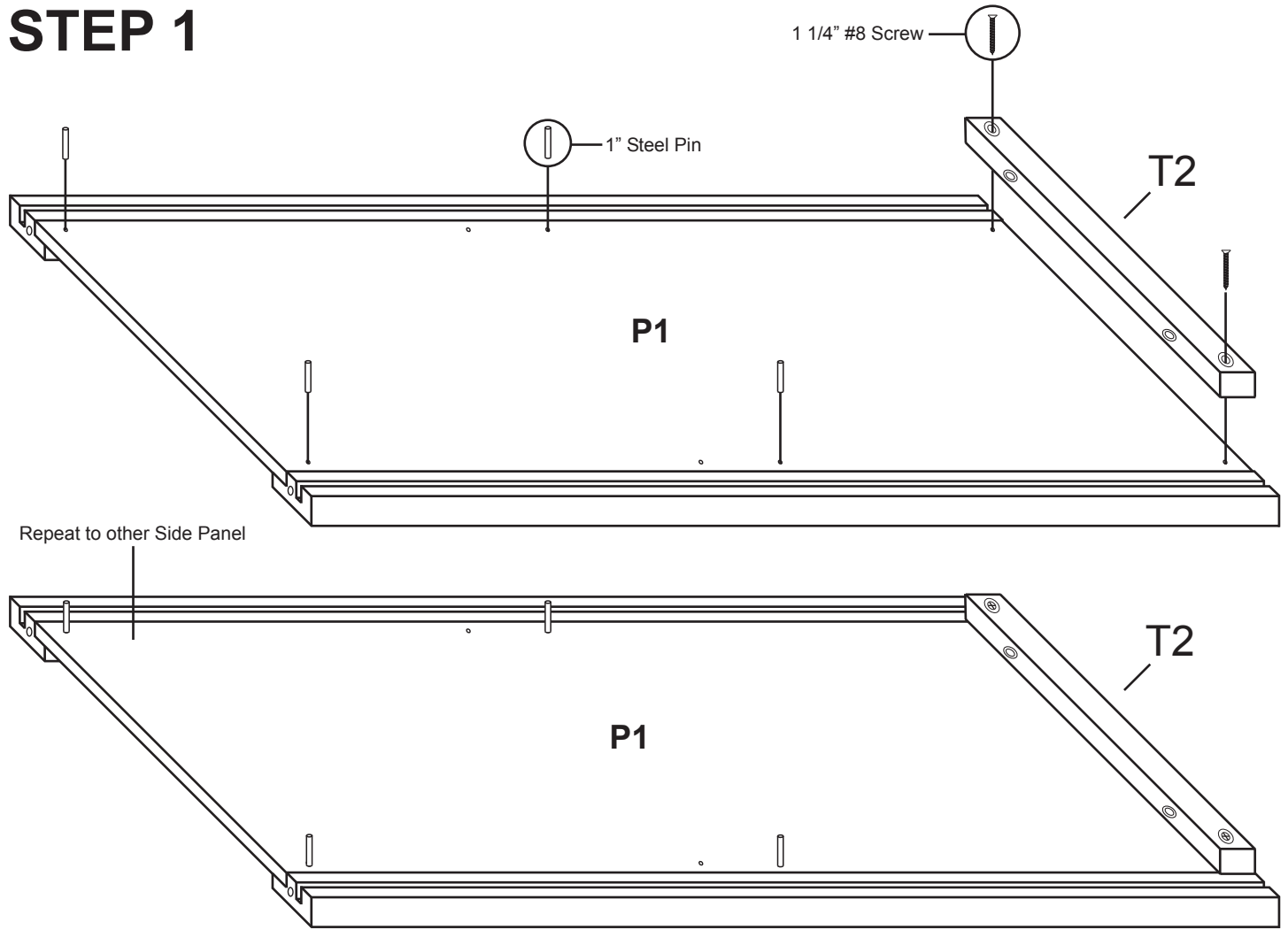

STEP 2

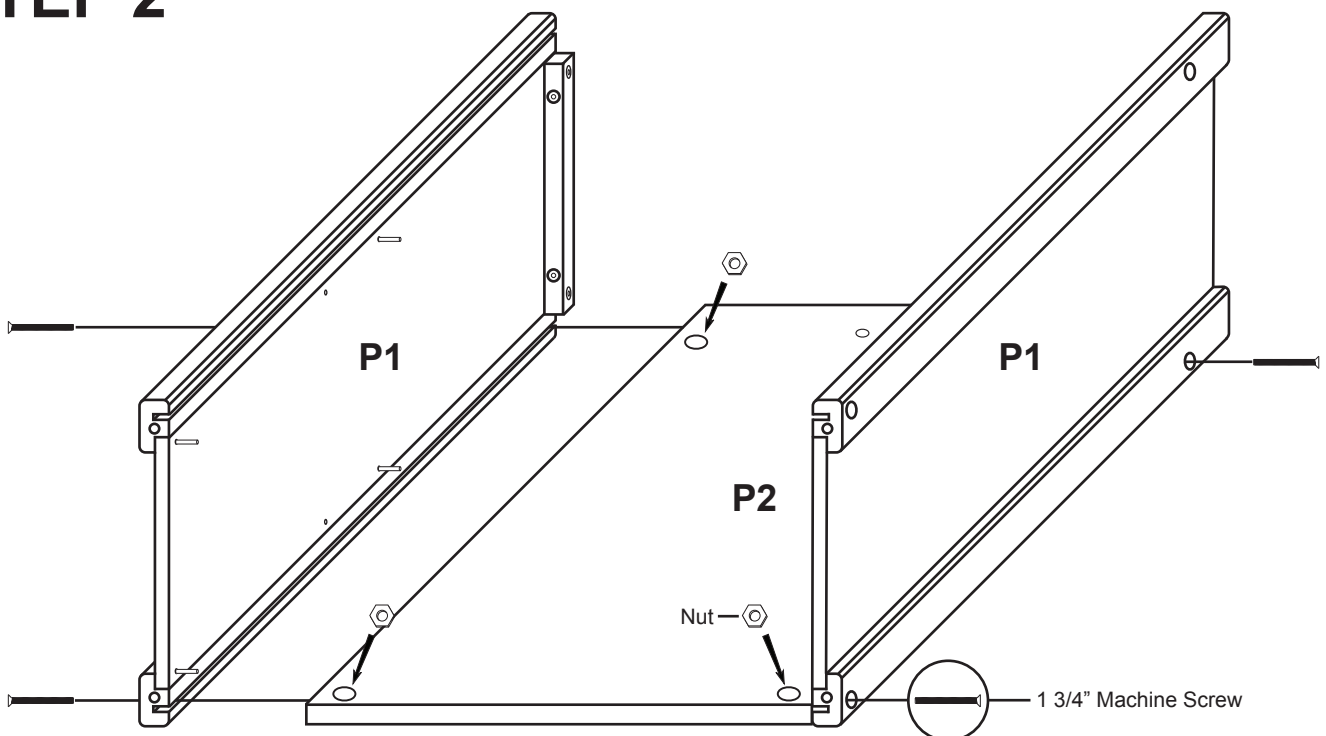

STEP 3

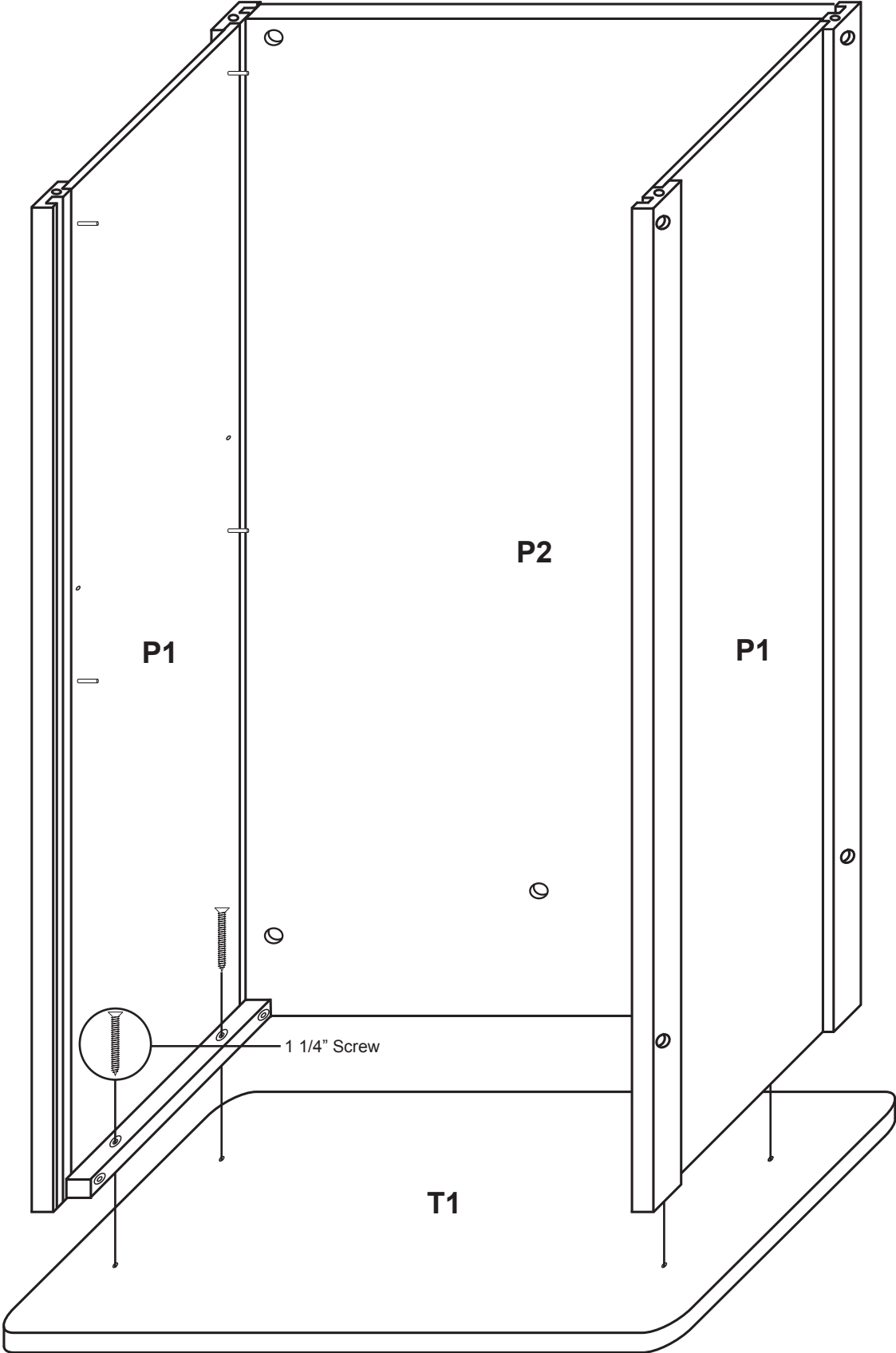

STEP 4

A. Attach the drawer back to the drawer sides with four 1 1/4" #8 screws. Make sure parts are aligned as in illustration 4A.

B. Insert drawer bottom into the slots in the drawer sides, best side to inside of drawer. Slide down until seated in the slot in the drawer back.

See illustration 4B.

C. Screw the cam posts into the two outside holes on the inside face of the drawer front until seated. Only 3/8" of this post goes into the wood, leaving the 4 guide rings/head exposed.

D. Insert the posts into holes in the drawer sides until seated against the front end of the drawer sides. Insert cams so that slot in the cam fits over the post and turn with Phillips screwdriver until seated. Don't over-torque! See illustration 4D.

E. Attach drawer handle with the two 1/2" handle screws (no illustration).

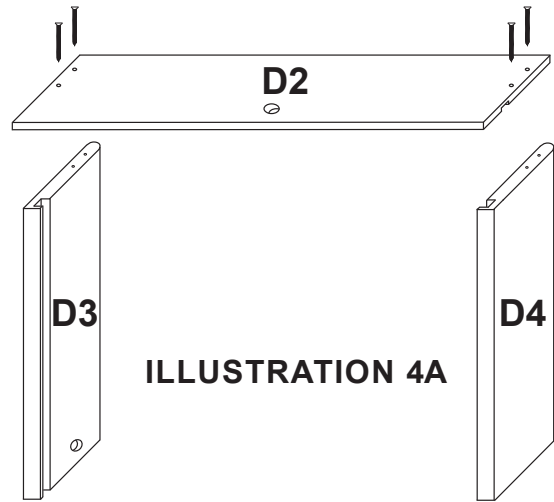

ILLUSTRATION 4A

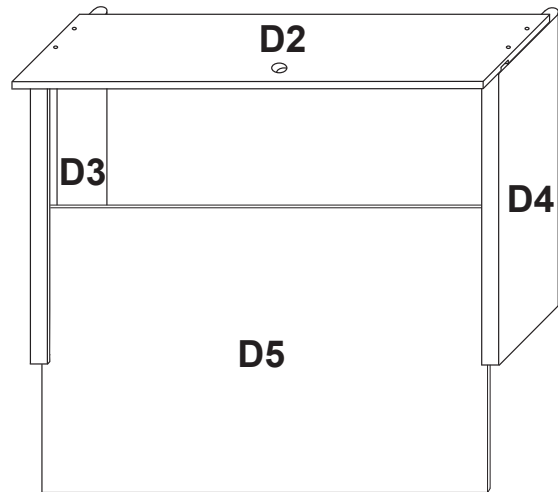

ILLUSTRATION 4B

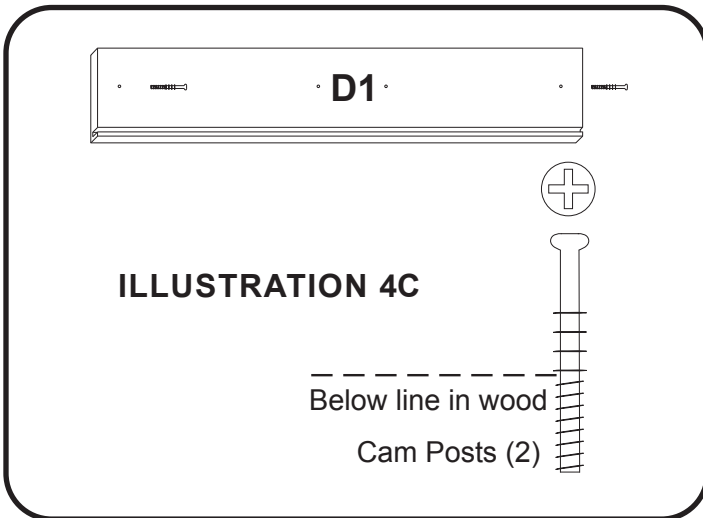

ILLUSTRATION 4C

Below line in wood
Cam Posts (2)

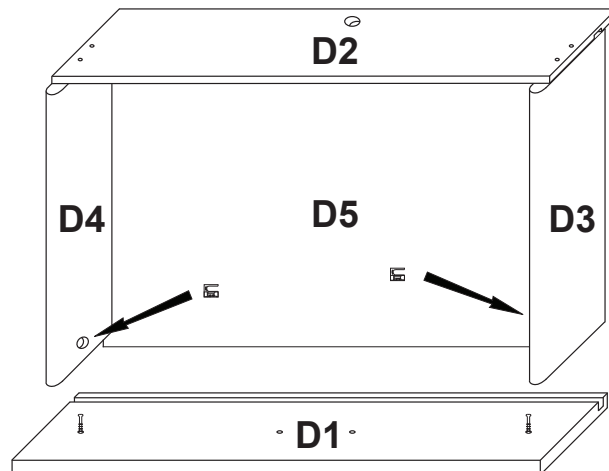
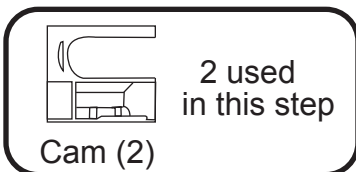
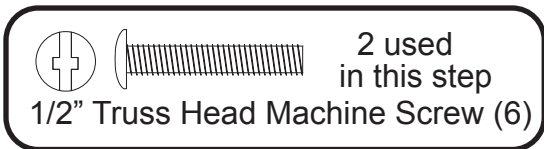
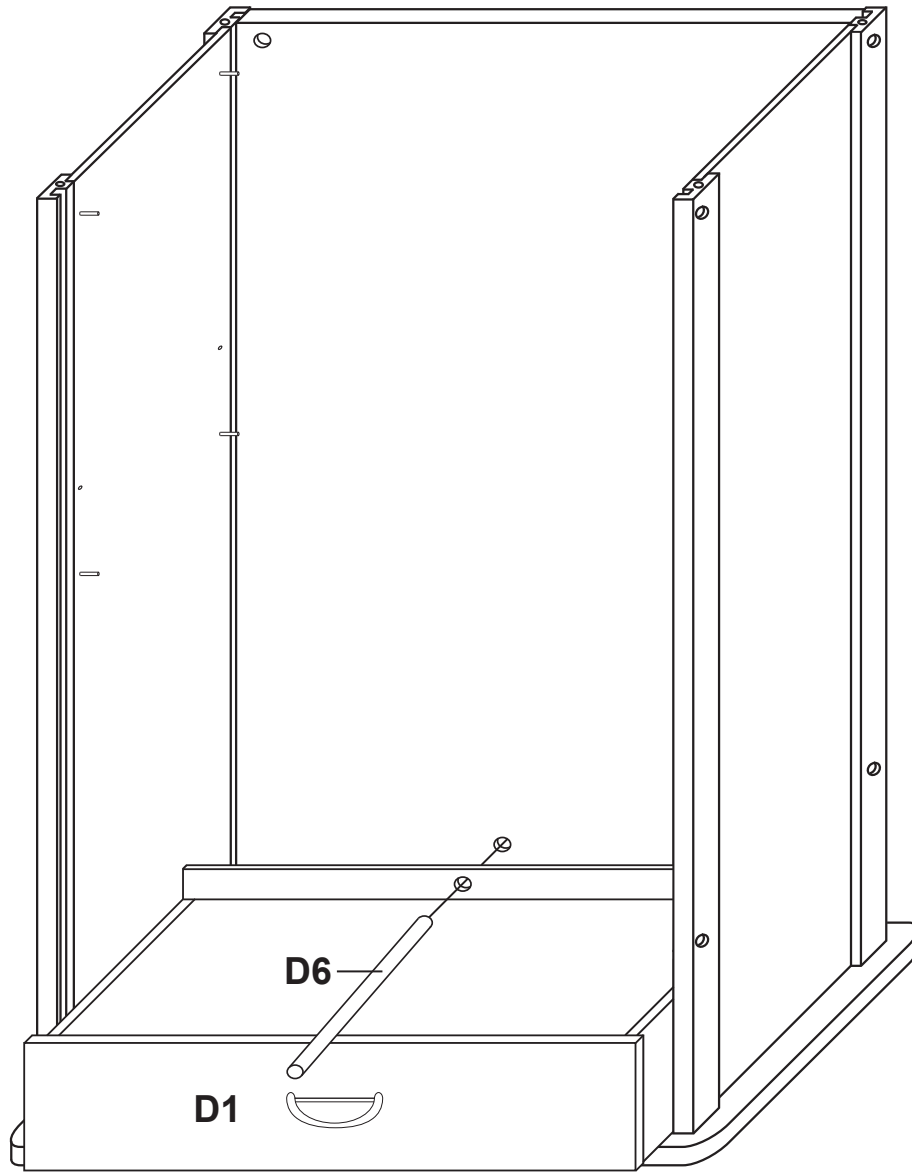

ILLUSTRATION 4D



STEP 5



Place drawer in position

STEP 6

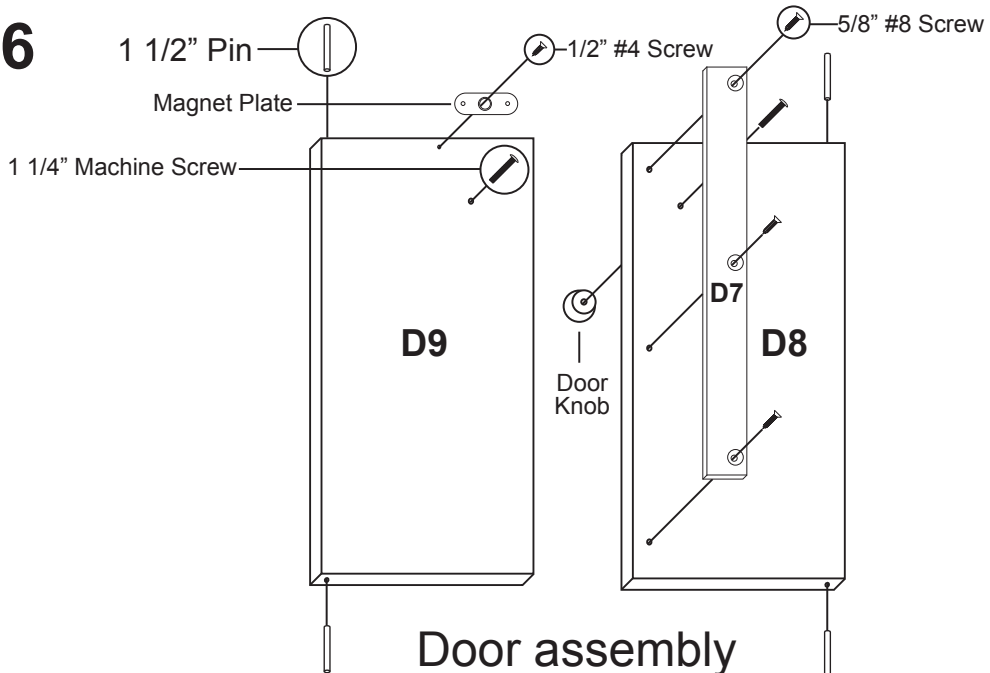

STEP 6

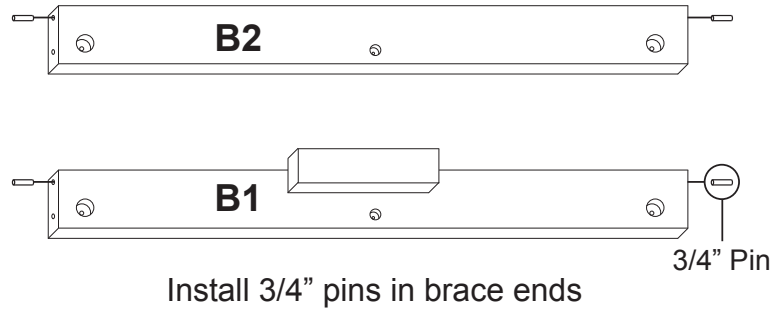

STEP 7

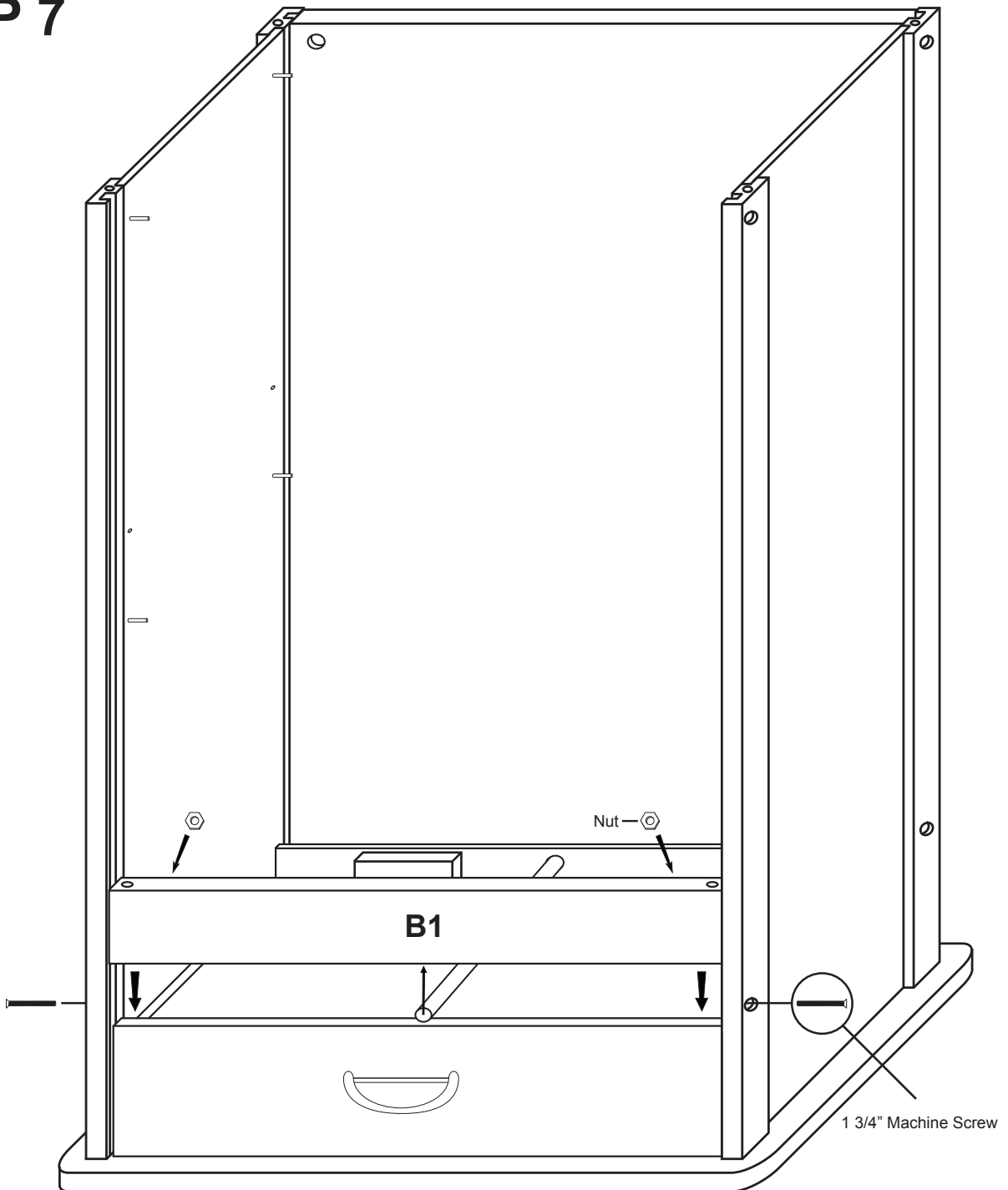

STEP 7

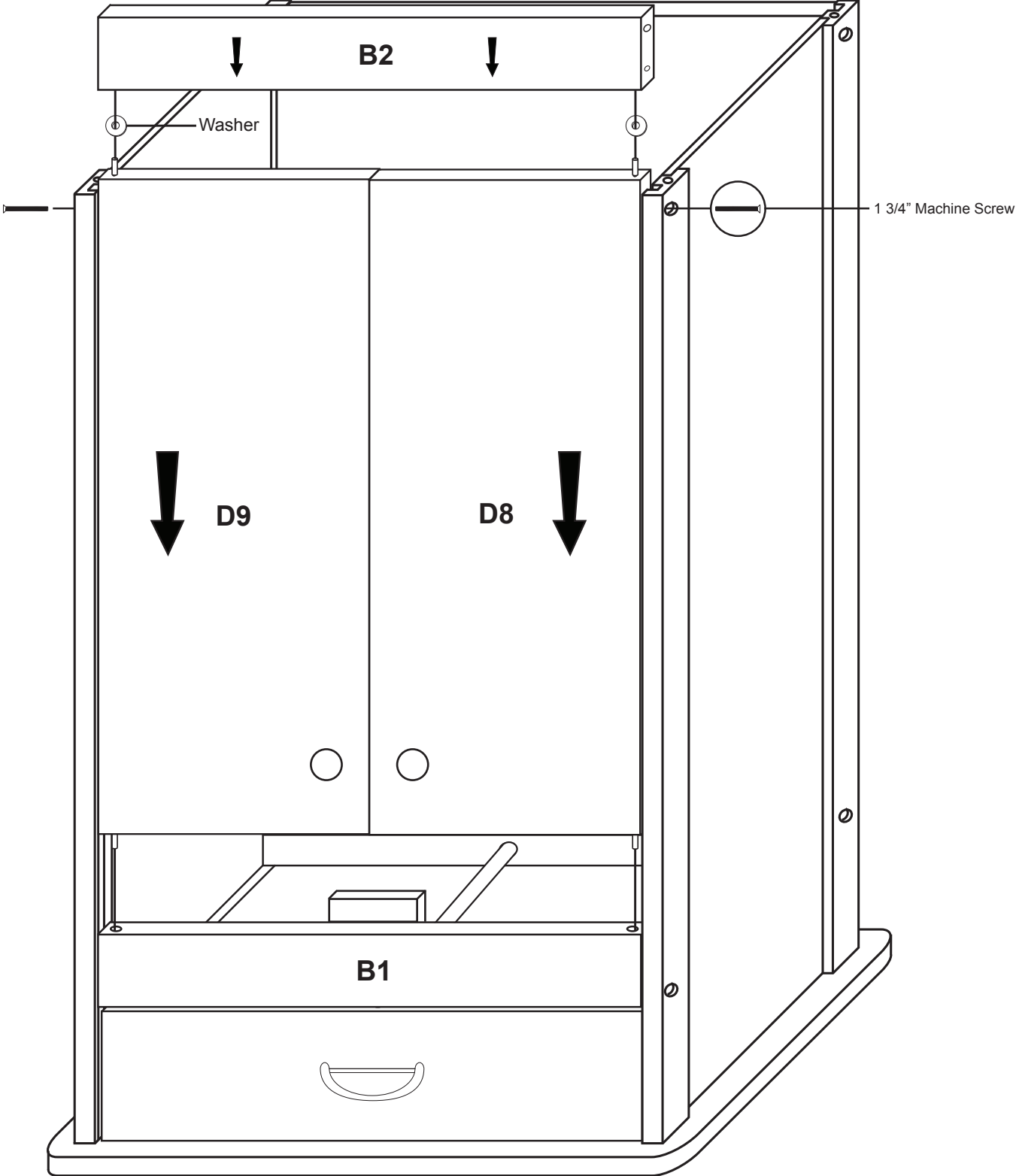

STEP 8

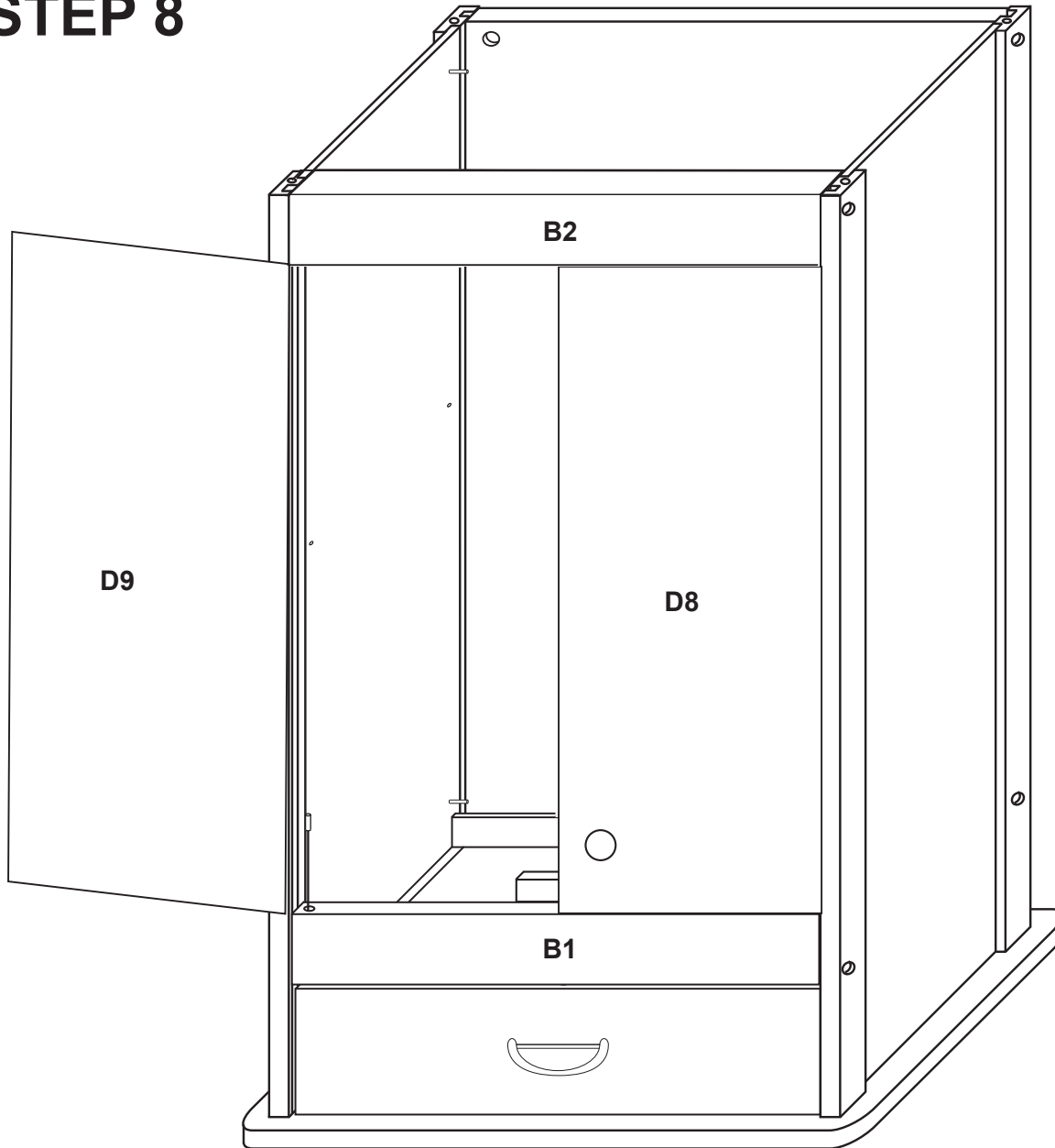

A. Stick magnet to magnet plate on right door.

B. With left door open, close the right door. The magnet should be positioned over the wooden block on the bottom of the top front brace. Hold the magnet in place with your thumb, and open the right door. The magnet will be in the correct position on the block.

C. Secure magnet with the two round head screws in the magnet packet. Center screws in the slots in the magnet. This will allow adjustment later, if needed.

NOTE: No pilot holes in block, as softwood!

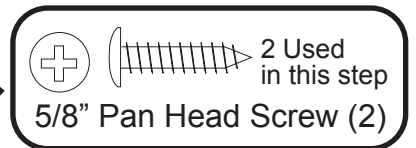
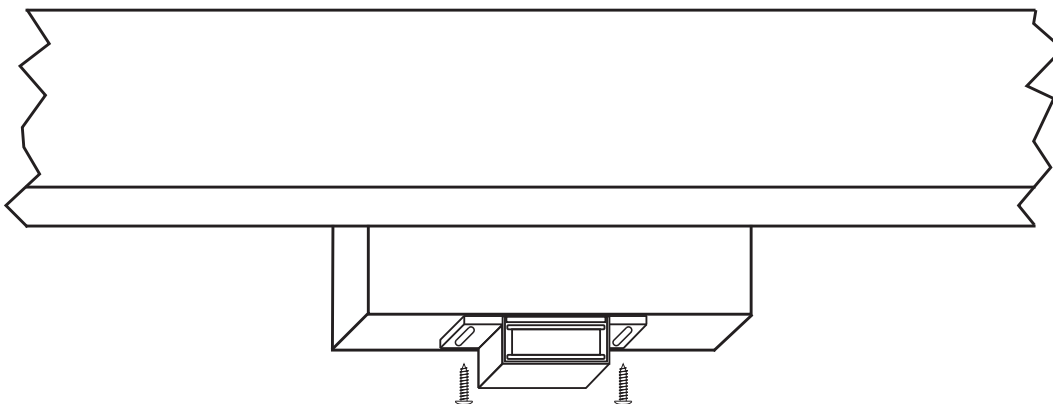

Magnet (1)

STEP 9

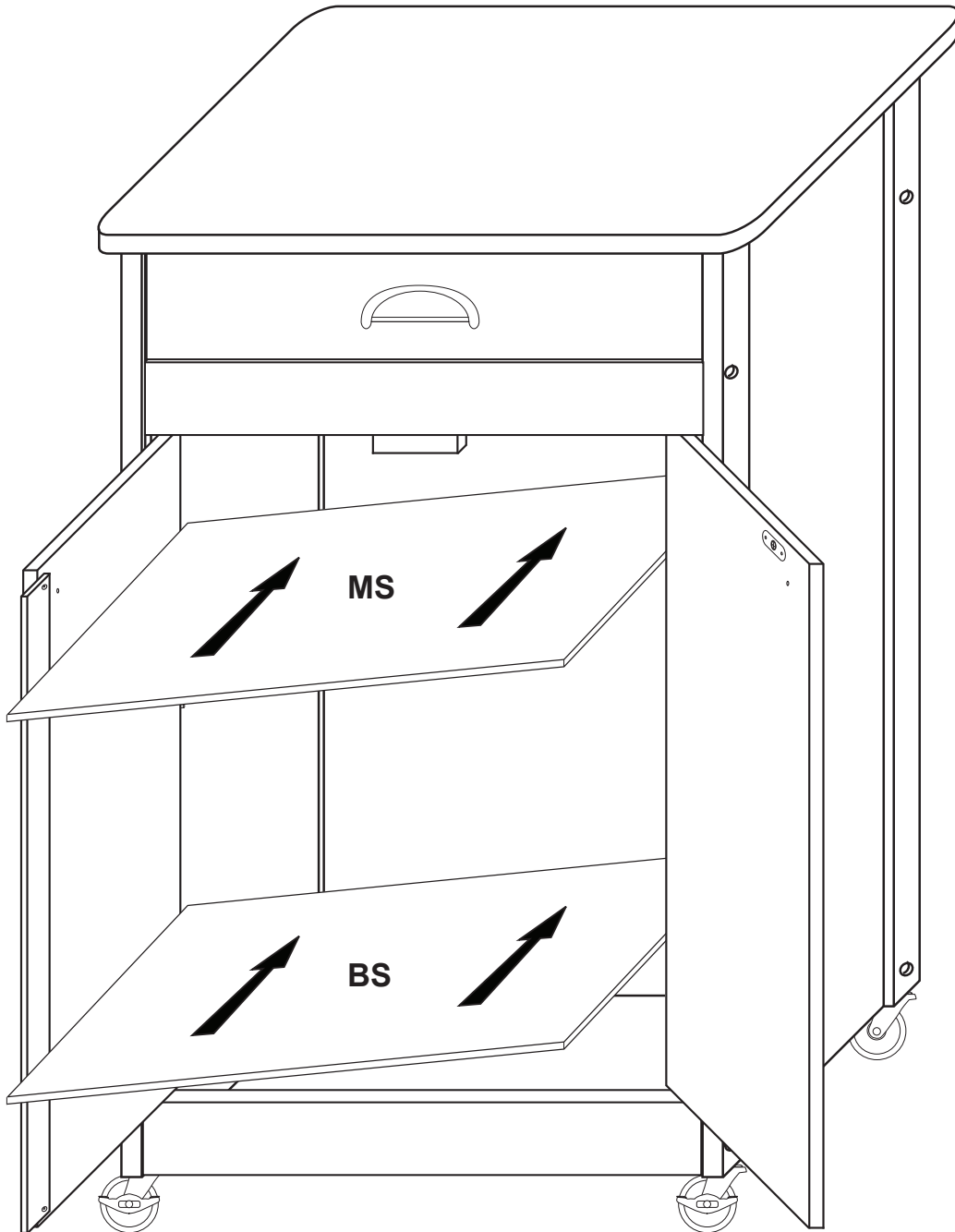
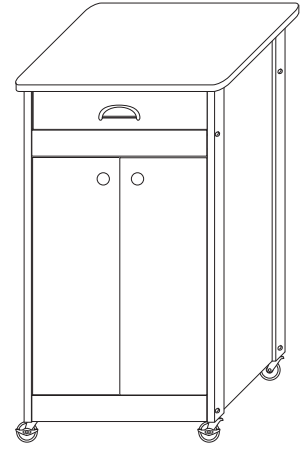
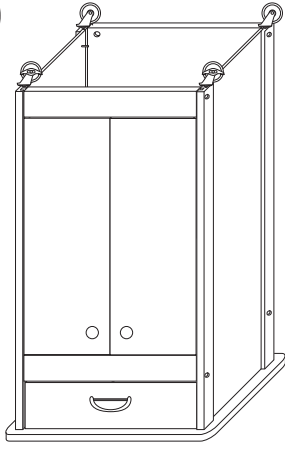

STEP 10

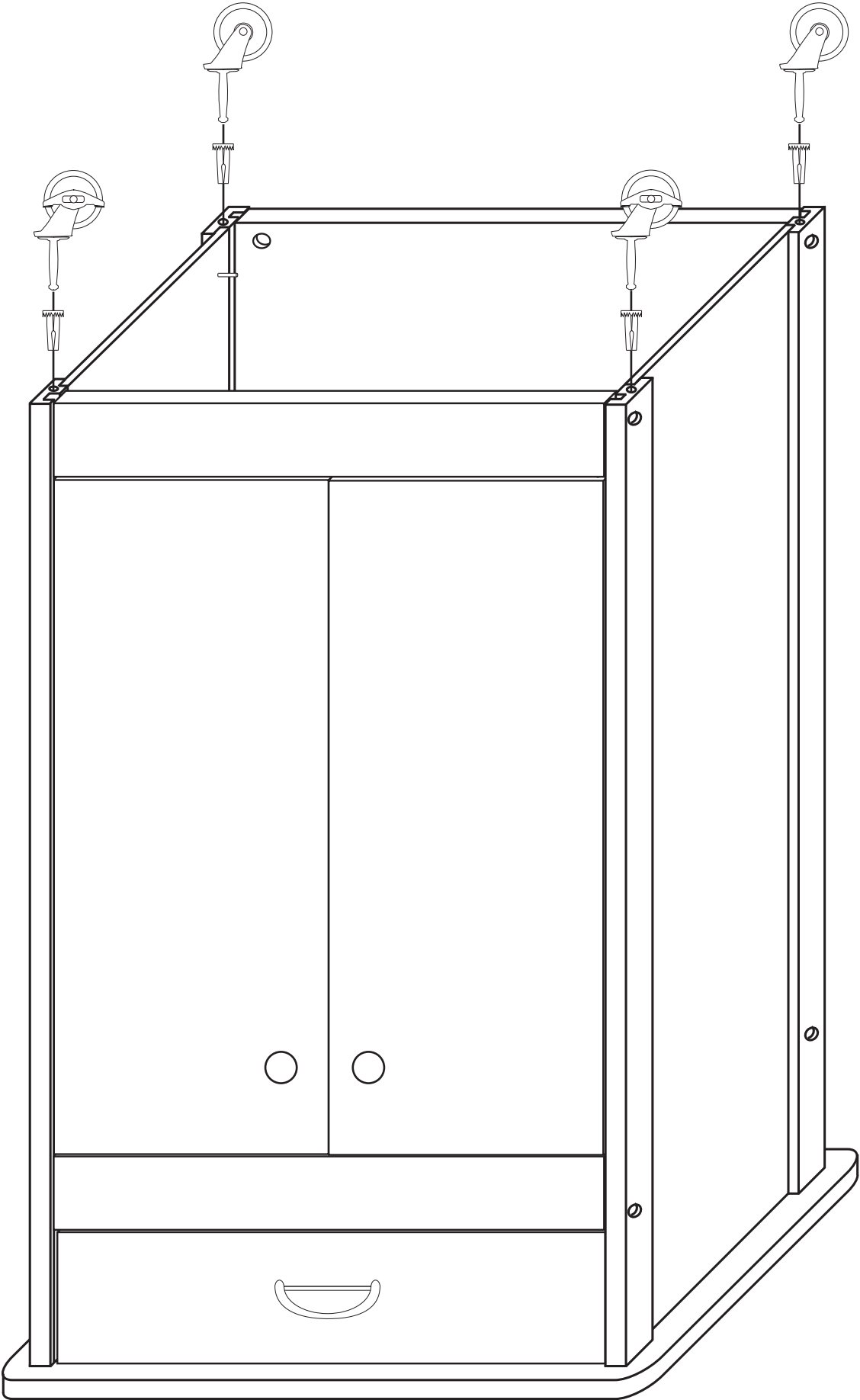

STEP 11

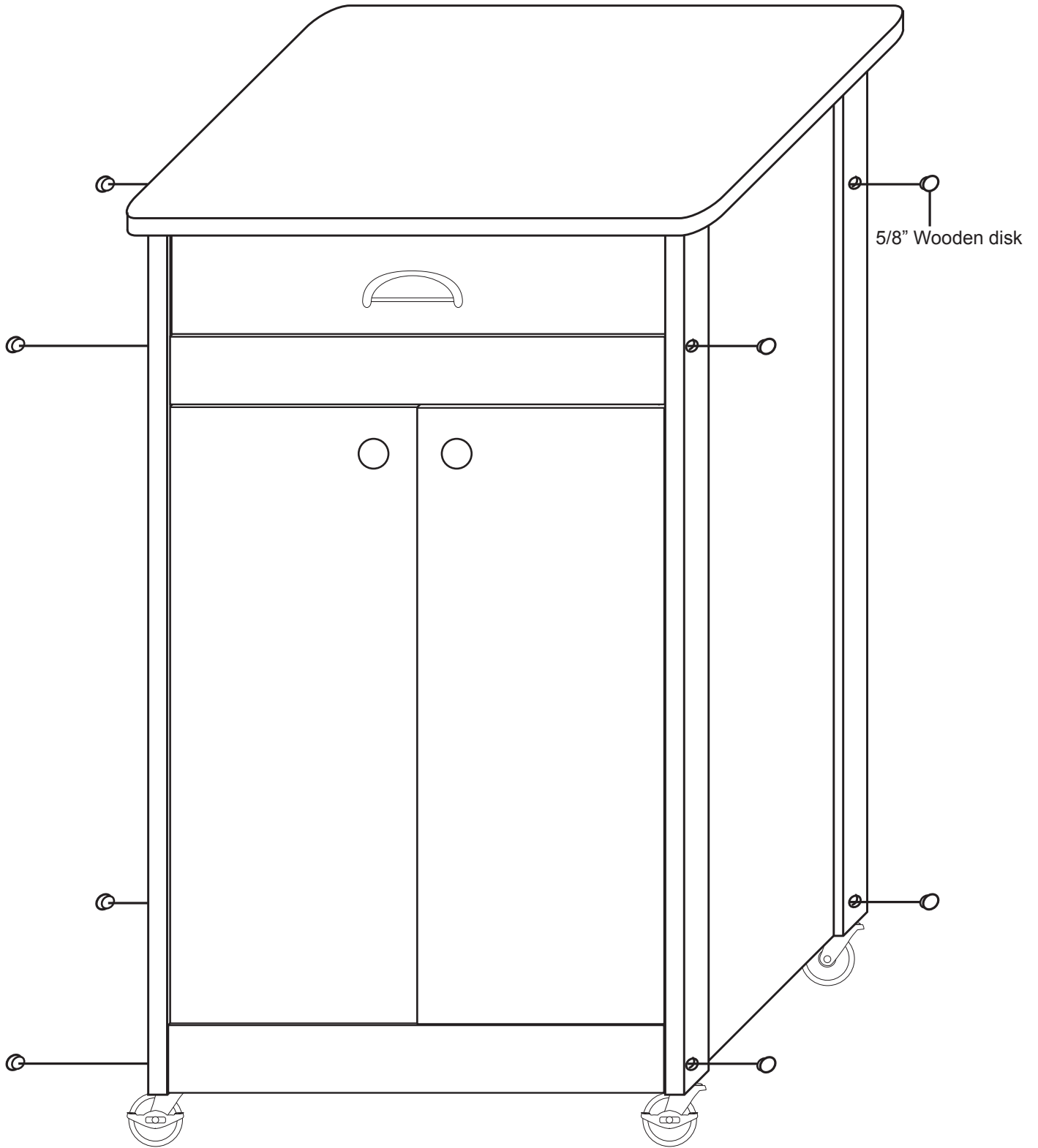

Tap in the 5/8" wooden disks. If you are afraid of marring the disks, you can cover them with a piece of paper.



For continued beauty and long life of your Catskill Craftsmen cart, we recommend Catskill Craftsmen's Butcher Block Oil.

If you would like to purchase Butcher Block Oil directly from Catskill Craftsmen's factory, we offer a reduced price. For one eight ounce (8 fl. oz.) bottle, which is sufficient for two applications, simply send \$6.95 along with the completed coupon to the address below or visit us online at www.catskillcraftsmen.com for other ordering options.



CATSKILL
CRAFTSMEN, INC.
BUTCHER BLOCK OIL COUPON

Please send me _____ # of bottle(s) of the Catskill Craftsmen Butcher Block Oil at \$6.95. My Check or Money Order is enclosed for a total of \$_____.

Item Code: 1529

NAME _____

ADDRESS _____

CITY _____

STATE _____ ZIP _____

Please make checks payable to: Catskill Craftsmen Inc.
15 West End Ave. Stamford, NY 12167-1296



Catskill Craftsmen, Inc.
15 West End Ave.
Stamford, NY 12167-1296